

AVF 125S: SUT valve actuator with spring return

How energy efficiency is improved

Electric cut-off and self-adjustment to save energy

Features

- Activation of 2-way and 3-way valves with female thread of the VUN/BUN, VUD/BUD and VUE/BUE series. For controllers with switching (2- and 3-point) or continuous output (0...10 V, 4...20 mA)
- Spring return moves the unit to the end position in the event of a power failure or when a limit controller is activated
- Stepping motor with SAUTER Universal Technology (SUT) electronic control unit and electronic, force-dependent cut-off
- Automatic recognition of applied control signal (continuous or switched)
- Coding switches for selecting characteristic and running time
- Type of characteristic (linear/quadratic/equal-percentage) can be set on the actuator
- Direction of operation can be selected via screw terminals when making the electrical connection
- Maintenance-free gear unit
- LED display
- Electrical connections (max. 1.5 mm²) with screw terminals
- Cable inlet M20 × 1.5
- Fitting vertically upright to horizontal, not suspended

Technical data

Power supply

Power supply	24 V~, ±20%, 50...60 Hz
Power consumption	5 W, 8.4 VA
Power consumption on starting ¹⁾	30 VA (max. 1 s)

Parameters

Running time of motor	60/120 s
Running time of spring	18 s ±10
Actuating power	500 N
Actuator stroke	0...8 mm

Positioner

Control signal 1	0...10 V, R _i = 100 kΩ
Control signal 2	4...20 mA, R _i = 50 Ω
Positional feedback signal	0...10 V; load > 2.5 kΩ
Starting point U ₀	0 or 10 V
Control span ΔU	10 V
Switching range X _{sh}	200 mV

Ambient conditions

Admissible ambient temperature	-10...55 °C
Admissible ambient humidity	< 95% rh, no condensation
Temperature of medium	Max. 100 °C

Construction

Weight	2.4 kg
Housing	Lower section black, cover transparent
Housing material	Fire-retardant plastic
Materials for gearbox and fitting bracket	Pressure-cast zinc

Standards and directives

Type of protection ²⁾	IP 54 (EN 60529)
Protection class	III (IEC 60730)
EMC directive 2004/108/EC	EN 61000-6-1, EN 61000-6-2 EN 61000-6-3, EN 61000-6-4

¹⁾ Only in the event of a restart or after a spring return

²⁾ Degree of protection IP 54 only with M20 cable gland

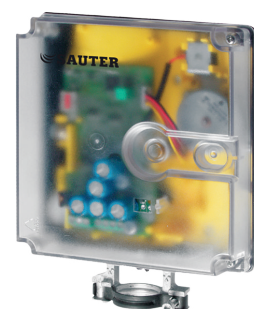

AVF125SF132



AVF125SF132



AVF125SF232

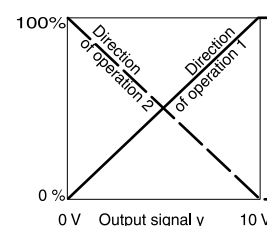



Software	A (EN 60730)
Mode of operation	Type 1 AA (200ms, EN 60730)
Machine directive 2006/42/EC (according to appendix IIB)	EN 12100

Overview of types

i For valves with equal-percentage characteristic; can be changed to linear

Type	Reset function
AVF125SF132	Actuator spindle retracted
AVF125SF232	Actuator spindle extended

 AVF125SF132: Actuator spindle normally moved in; valve normally closed (NC) with VUD, BUD, VUE, BUE, VUN, BUN
 AVF125SF232: Actuator spindle normally moved out; valve normally open (NO) with VUD, BUD, VUE, BUE, VUN, BUN

Accessories

Type	Description
0313529001	Split-range unit for adjusting sequences, fitted in separate junction box
0370881001	Auxiliary change-over contacts, single
0370882001	Auxiliary change-over contacts, single, combined with pot. 2000 Ω, 1 W; 24 V
0370882006	Auxiliary change-over contacts, single, combined with pot. 1000 Ω auxiliary change-over contacts, 1 W; 24 V
0370883001	Potentiometer, 2000 Ω, 1 W; 24 V
0370883006	Potentiometer, 1000 Ω, 1 W; 24 V
0372249001	Adaptor required when media temperature > 100 °C (recommended for temperatures < 10 °C)
0372460001	Cable screw fitting (plastic M20 × 1,5) incl. locking nut and seal

 Auxiliary change-over contacts: Infinitely variable, admissible load 2(1) A, 12...250 V~, min. load 250 mA, 12 V~

Description of operation

When the device is restarted, or when it is started after the reset is triggered, there is a waiting time of 45 s until the reset function is available. Depending on the type of connection (see connection diagram), the actuator can be used as a continuous 0...10 V and/or 4...20 mA as 2-point (OPEN/CLOSE) or 3-point actuator (OPEN/STOP/CLOSE) with an intermediate position. When control signals 1 (3u / 03) and 2 (3i / 04) are connected simultaneously, the input with the highest value has priority over the other.

The running time of the actuator can be set with switches S1 and S2 according to requirements. Switches S3 and S4 can be used to select the equal-percentage, linear or quadratic characteristic. The AVF 124S is combined with valves that have a linear basic characteristic like the VXN and BXN valves. The AVF 125S is combined with valves that have an equal-percentage basic characteristic like the VUD, BUD, VUE and BUE valves. The AVF 125S can be mounted on a valve with a linear characteristic (e.g. VUE 050F200), but the position of the coding switch must be considered.

Intended use

This product is only suitable for the purpose intended by the manufacturer, as described in the "Description of operation" section.

All related product documents must also be adhered to. Changing or converting the product is not admissible.

Connection as 2-point actuator

This 2-point activation can be performed via 2 cables. The actuator is connected to the voltage via terminals 1 / MM and 2a / 01. The control passage of the valve is opened by connecting the voltage to terminal 2b / 02. After this voltage is switched off, the actuator moves to the opposite end position and closes the valve.

Connection as 3-point control unit

When voltage is applied to terminal 2a / 01 or 2b / 02, the valve is moved to any desired position. The coupling rod moves out and opens the valve when voltage is applied to terminals 1 / MM and 2b / 02. It moves in and closes the valve when the electrical circuit is closed via terminals 1 / MM and 2a / 01.

In the end positions (limit stop in valve or maximum stroke reached) or in the case of an overload, the electronic motor cut-off is activated (no limit switches). Direction of the stroke changed by transposing the connections (2a, 2b / 01, 02).

Connection for control voltage 0...10V and/or 4...20 mA

The built-in positioner controls the actuator depending on controller's output signal y.

Voltage signal 0...10 V- is applied via terminal 3u / 03 and current signal via terminal 3i / 04.

Direction of operation 1 (mains power supply on internal connection 2a / 01):

When the positioning signal is increasing, the coupling rod moves out and opens the valve (control passage).

Direction of operation 2 (mains power supply on internal connection 2b / 02):

When the positioning signal is increasing, the coupling rod moves in and closes the valve (control passage).

The starting point and the control span are fixed. A split-range unit (accessory) is available for setting partial ranges and only for control signal 1.

After a mechanical reset or a power failure, the actuator automatically readjusts itself. When an adjustment is required, this can be triggered using the push-button on the electronic printed circuit board (top left).

After the power supply is connected, the stepping motor moves to the lower limit stop, closes the connection with the valve spindle, moves to the upper limit stop and thus defines the closing position.

After this, every stroke between 0 and 8 mm can be achieved, depending on the control voltage.

Thanks to the electronics, no steps can be lost, and the actuator does not require periodic re-adjustment. It is possible to operate multiple actuators of the same type in parallel.

If the supply voltage fails or is switched off, or if a monitoring contact is activated, the holding magnet releases the gear unit and the preloaded spring moves the actuator to the end position, depending on the model of the actuator. Additionally, the control function of the actuator is locked for 45 s so that the end position is definitely reached. The reset function is braked depending on the speed, so that no pressure surges can occur in the supply line.

The feedback signal y0 = 0...10V corresponds to the effective stroke of 0 to 8 mm.

When control signal 0...10V is interrupted and direction of operation 1 is connected, the valve is closed completely (0% position).

The coding switch can be used to select the characteristic of the valve. Characteristics can only be generated when the actuator is used as a continuous actuator. The running times can be selected with additional switches. These can be used regardless of whether the 2-point, 3-point or continuous function is selected.

Coding switch for selecting running time

AVF 124S, AVF 125S

Run time per mm	Switch coding	Run time for 8 mm stroke
7,5 s		60 s ± 2
15 s		120 s ± 4
= factory setting		

Coding switch for selecting characteristic

AVF 125S

Desired character. curve	Switch coding	Characteristic curve for valve	Characteristic curve for drive	Effective on valve
Equal percentage				
Quadratic				
Linear				
Equal percentage				
Linear				

= factory setting

LED indicator: Operation

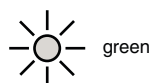

auto-reset (initialisation)	
at a standstill (setpoint=actual-position, manual handling)	
drive moves in setpoint direction	
too much force detected	

LED indicator: Safety function



after spring return (40...55s)	
normally	

Split-range unit (accessory 0313529):

Starting point U_0 and control span ΔU can be set with the potentiometer. In this way, several control units can be operated in sequence by the control signal of the controller. When this accessory is installed, auxiliary contacts or potentiometers can no longer be installed.

Engineering and fitting notes

Condensate, dripping water, etc. must be prevented from entering the actuator along the valve spindle.

The actuator/valve is mounted by inserting and tightening screws without any additional adjustment. The device is delivered ex works in the open or middle position. With the “normally closed” model, the spacer on the stroke rod must be removed when the valve is mounted.

The concept of stepping motor and electronics enables parallel operation of multiple valve actuators of the same type.

The maximum accessory equipment is 1 stroke indicator and 1 additional accessory of auxiliary contacts, potentiometer or combination or split-range unit.

The power consumption when starting up is relatively high. It only occurs during a restart or after a spring return and lasts for max. 1 s. A random delay of up to 20 s is incorporated into the actuator so that, during the parallel operation of multiple actuators, not all of them are switched on at the same time. The cable cross-section and the transformer rating must correspond to the cable length:

Cable length	Cable cross-section	Transformer rating
Max. 30 m	0.75 mm ²	30 VA
Max. 60 m	1.5 mm ²	30 VA
Max. 100 m	1.5 mm ²	50 VA

Outdoor installation

If installed outside of buildings, the devices must be additionally protected from the weather.

Disposal

When disposing of the product, observe the currently applicable local laws.

More information on materials can be found in the Declaration on materials and the environment for this product.

Connection diagram

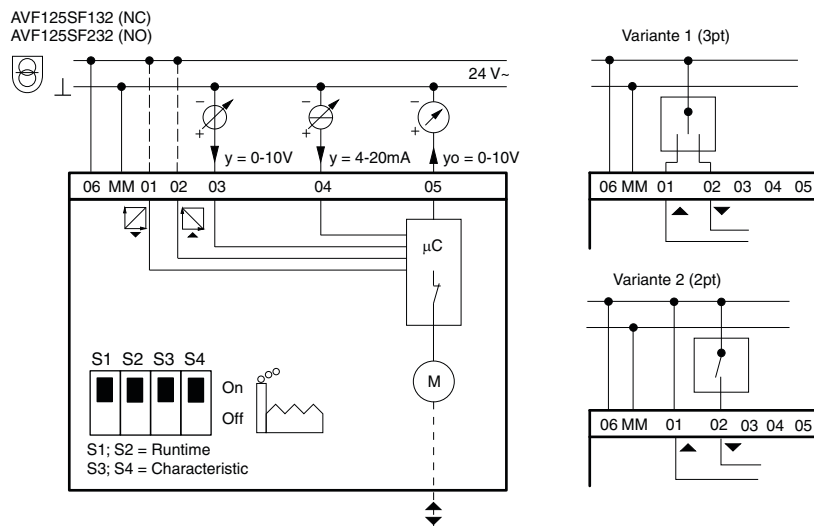

NC = without auxiliary energy closed (normally closed)
 NO = without auxiliary energy open (normally open)

Accessories

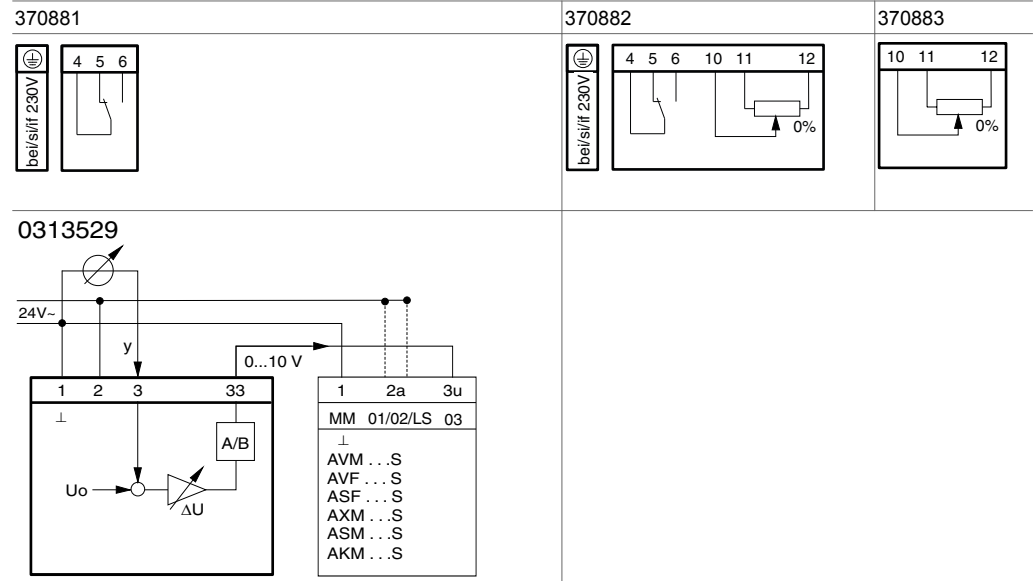

Dimension drawing

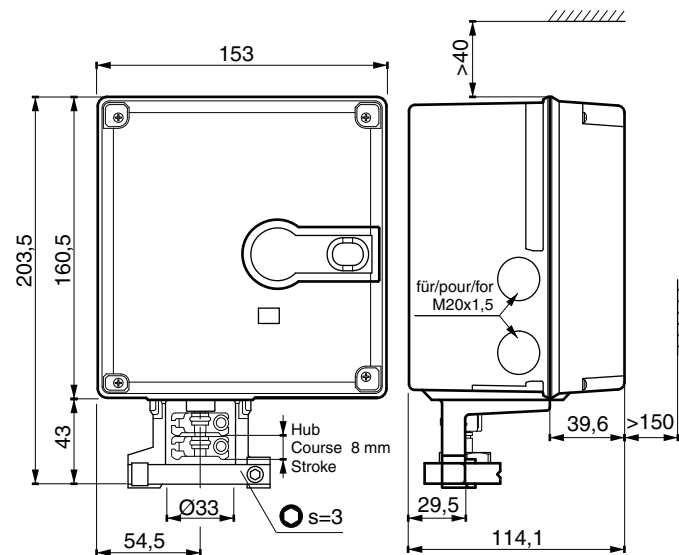

Accessories

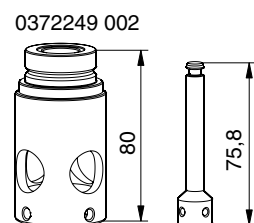
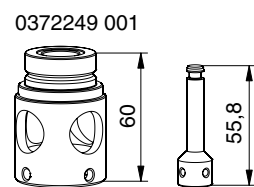

Fr. Sauter AG
 Im Surinam 55
 CH-4016 Basel
 Tel. +41 61 - 695 55 55
 www.sauter-controls.com