

## EY6LC12: IP coupler for I/O modules, with web server, modu612-LC

### Features

- Part of the SAUTER modulo 6 system family
- Enables decentralised installation and connection of the modulo 6 COM and IO modules with the automation station via IP network
- Locally expandable with up to 10 modules
- Two RJ45 connections switched for daisy chain
- Integrated web server for local commissioning
- Bluetooth interface for mobile commissioning and maintenance
- User administration and user identification (web server)



EY6LC12F011

### Technical data

| Power supply                      |                           |   |
|-----------------------------------|---------------------------|---|
| Power supply                      |                           | 24 VDC ± 10%  |
| Power consumption <sup>1)</sup>   |                           | ≤ 2 W without load<br>≤ 24 W at maximum load  |
| Dissipated power                  |                           | ≤ 2 W without load<br>≤ 4 W at maximum load   |
| Peak inrush current <sup>2)</sup> |                           | ≤ 20 A, ≤ 1 ms on the 24 V side   |
| Parameters                        |                           |   |
| Connection                        |                           | 3-pin spring-type terminal, pluggable,<br>0.5...1.5 mm <sup>2</sup> (rigid)<br>0.5...2.5 mm <sup>2</sup> , min. 8 mm wire strip-<br>ped |
| Battery (buffer: RTC)             |                           | CR2032, pluggable   |
| Earth connector                   |                           | Spring contact against DIN rail and<br>PE terminal  |
| Ambient conditions                |                           |   |
| Operating temperature             |                           | 0...45 °C   |
| Storage and transport temperature |                           | -20...70 °C   |
| Ambient humidity                  |                           | 10...90% rh, no condensation  |
| Architecture                      |                           |   |
| Processor                         |                           | ARM Cortex A8, 32-bit, 600 MHz  |
| Flash                             |                           | 256 MB  |
| Embedded web server               |                           | moduWeb Unity   |
| Application data                  |                           | From the automation station   |
| Interfaces, communication         |                           |   |
| Ethernet network                  | Ethernet network          | 2 × RJ45 connector, switched  |
|                                   | 10/100 BASE-T(X) switched | 10/100 Mbit/s   |
| Construction                      |                           |   |
| Dimensions W × H × D              |                           | 92.6 (5 HP) × 97 × 58.3 mm  |
|                                   | Fitting                   | On metal DIN rail<br>35 × 7.5/15 as per EN 60715.<br>Rail housing as per DIN 43880  |
| Weight                            |                           | 226 g   |
| Standards, directives             |                           |   |
| Type of protection                |                           | Connections: IP00<br>Front in DIN cut-out: IP30<br>(EN 60730-1)   |
| Protection class                  |                           | I (IEC 60730-1)   |
| Environment class                 |                           | 3K3 (IEC 60721)   |
| Software class                    |                           | A (EN 60730-1, Appendix H)  |

<sup>1)</sup> Maximum load with 10 I/O modules

<sup>2)</sup> Measured value with EY-PS021F021 power supply unit



|                                  |   |   |
|----------------------------------|---|---|
|                                  | Temperature controller class            | I to VIII = up to 5%<br>as per 2010/30/EU & 811/2013 (EU) |
| CE/UKCA conformity <sup>3)</sup> | EMC-D 2014/30/EU (CE)                   | EN 50491-5-1, EN 50491-5-2,<br>EN 50491-5-3               |
|                                  | EMC-2016 (UKCA)                         | See EMC Directive   |
|                                  | LV-D 2014/35/EU (CE)                    | EN 60730-1, EN 60730-2-9,<br>EN 62479                     |
|                                  | EESR-2016 (UKCA)                        | EN 60730-1, EN 60730-2-9,<br>EN 62479                     |
|                                  | RED 2014/53/EU (CE)                     | EN 300328 (V2.1.1)  |
|                                  | RER-2017 (UKCA)                         | EN 300328 (V2.1.1)  |
|                                  | RoHS-D 2011/65/EU &<br>2015/863/EU (CE) | EN IEC 63000  |
|                                  | RoHS-2012 (UKCA)                        | EN IEC 63000  |

#### Overview of types

| Type        | Description                                 |
|-------------|---|
| EY6LC12F011 | IP coupler for I/O modules, with web server |

#### Accessories

##### Plug-in I/O modules

| Type        | Description   |
|-------------|---|
| EY6IO30F001 | modu630-IO 16 × DI/CI inputs I/O module                     |
| EY6IO31F001 | modu631-IO 8 × UI(DI/CI/AI), 8 × DI/CI I/O module           |
| EY6IO50F001 | modu650-IO 6 × relay (2 A) outputs I/O module               |
| EY6IO70F001 | modu670-IO 8 × DI/CI/DO(OC), 8 × DI/CI I/O module           |
| EY6IO71F001 | modu671-IO 8 × AO, 8 × DI/CI I/O module                     |
| EY6IO72F001 | modu672-IO 4 × AO, 4 × DO(OC), 4 × UI (DI/CI/AI) I/O module |

##### Plug-in communication modules (COM)

| Type        | Description                              |
|-------------|--|
| EY6CM20F011 | Modbus/RTU (RS-485) communication module |
| EY6CM30F031 | modu630-CM M-Bus communication module    |

##### Connection modules

| Type        | Description   |
|-------------|---|
| EY6LC01F001 | Module for separate I/O module supply                               |
| EY6LC02F001 | Coupling kit for I/O modules in cabinet (P100017761 and P100017762) |

##### Spare parts

| Type       | Description                        |
|------------|------------------------------------|
| 0929360602 | AS bus cover with resistor, 5 pcs. |

#### Manuals

| Document number | Language | Title                                |
|-----------------|----------|--------------------------------------|
| D100397589      | de       | Systembeschreibung SAUTER modulo     |
| D100408512      | de       | EY-modulo 6 – Best Practice I        |
| D100402674      | en       | SAUTER modulo system description     |
| D100410201      | en       | EY-modulo 6 – Best Practice I        |
| D100402676      | fr       | Description du système SAUTER modulo |
| D100410203      | fr       | EY-modulo 6 – Meilleures pratiques I |

## Description of operation

The modulo 6 system family comprises a range of communicative automation stations, I/O and COM modules for building automation via IP networks, based on the BACnet standard.

IO and COM modules can be installed decentrally with the modu612-LC IP coupler. The data is exchanged between the IP coupler and the associated modulo 6 automation station via the IP network. Communication with an automation station is based on the client-server principle, in which

<sup>3)</sup> Explanation of abbreviations in the "Further information" section of the product data sheet and in the appendix to SAUTER's product catalogues

the station assumes the role of the server. New values are transferred when the threshold is exceeded. In addition, all values are queried periodically in sequence.

The integrated moduWeb Unity web server is suitable for commissioning and maintenance of the device.

With the help of the powerful CASE Suite programming environment and the available function libraries, standard building automation tasks can be carried out and complex projects created with the integration of subsystems via IP/network or field buses. Programming is carried out for the associated modulo 6 automation station, which maps all networked data points as BACnet objects.

COM modules can be connected to the IP coupler and support integration via the Modbus or M-Bus interfaces of special actuators, sensors, operating devices or subsystems.

The IP coupler can be preconfigured via the Bluetooth interface and with the SAUTER app.

Special standards such as IEC 61508, IEC 61511, IEC 61131-1 and IEC 61131-2 were not considered during the development.

### Intended use

This product is only suitable for the purpose intended by the manufacturer, as described in the "Description of operation" section.

All related product regulations must also be adhered to. Changing or converting the product is not admissible.

### Improper use

The SAUTER modulo 6 system does not have functional safety and is not fail-safe. MTTF, MTBF and MTTR data is not available.

This product is not suitable:

- For safety functions
- In transportation equipment and storage facilities as per Regulation 37/2005
- As a measuring device as per EU Measuring Instruments Directive 2014/32/EU
- In outdoor areas and in rooms with the risk of condensation
- On means of transport, e.g. ships.

### Engineering and fitting notes



#### Notice

Only qualified electricians are permitted to fit and connect the module.  
Prevent access by laypersons.

The modu612-LC is mounted in a cabinet using a DIN rail (EN 60715).

You must ensure that it is not installed in the immediate vicinity of power contactors, frequency converters or other EMC interference sources. SAUTER generally recommends installation in a separate DDC cabinet field. During installation, there must also be an external, primary isolating facility. Connection may only be performed when the system is disconnected from the electrical supply. All plant devices are connected via pluggable spring-type terminals. When the power supply is being connected, the protective earth must also be connected to the corresponding terminal (protection class I).

Further recommendations can be found in the document "EY-modulo 6 – Best Practice I".

The communication wiring must be carried out professionally and in accordance with the requirements of standards EN 50174-1, EN 50174-2 and EN 50174-3. Communication and plant device wiring must be separated from current-carrying wiring.

Cat.6A with S/FTP shielding is recommended for the Ethernet connection to the automation station.

Local requirements regarding installation, usage, access, access rights, accident prevention, safety, dismantling and disposal must be taken into account. Furthermore, installation standards such as EN 50178, EN 50310, EN 50110, EN 50274 and EN 61140 must be complied with.

### Signals and latency

The Ethernet connection between the IP coupler and the automation station results in an additional latency. In some cases, this can be critical for the application. For example, digital signals above 2 Hz may not be reliably detected.

### Bus cover

The modu612-LC is supplied with a bus cover. This must be fitted on the right, free side, either on the IP coupler or on the last I/O or COM module.



#### Note

The bus cover must always be fitted.

A terminating resistor is installed in the cover to prevent signal reflections and data transmission interference. The cover also protects the spring contacts from short circuits and damage.

Further information on fitting and installation can be found in the fitting instructions for the IP coupler.

### Power supply

The device is suitable for operation at 24 V DC. Operation with EY-PS 031 switched-mode power supply is recommended as it is optimally matched to the modu612-LC. It is necessary to use a double-insulated power supply.

DC operation has the lowest power loss and heat generation. This prolongs the serviceable life and minimises the device's own consumption.

The maximum ampacity of the connection terminals must be complied with; to this end, external fuse protection is essential in all cases. When a current-limiting power supply unit is used, such as EY-PS 031, fuse protection in the secondary electrical circuit is not necessary. The fuse required for the primary electrical circuit on the 24 V power supply unit can be found in the manufacturer's instructions.

The voltage source is selected according to the aggregate current consumption of the modu612-LC and all the connected devices. A reserve of at least 15% should be taken into account when selecting the voltage source or the switched-mode power supply.



#### Note

Fieldbus devices and other devices such as automation stations should not be supplied from the same 24 V DC source.



#### Recommendation

To increase EMC immunity to burst interference, a braid breaker (e.g. Würth split ferrite 74271132) can be attached to the supply line.

### Earth

The earth connector on the modu612-LC is the protective earth and must always be connected to the earth for safety and EMC reasons.

Earthing is performed exclusively at the earthing terminals of the modu6 devices. Signal ground terminals must not be earthed. MM and conductors of the 24 V power supply units must not be earthed.

### Reset button

The modu612-LC can be reset to the factory state using the reset button. The reset button must be pressed for at least 10 seconds. The LED indicator changes between green, red and orange until the device is reset and/or restarted.

If the reset button is pressed for less than 10 seconds, the device will simply be restarted.

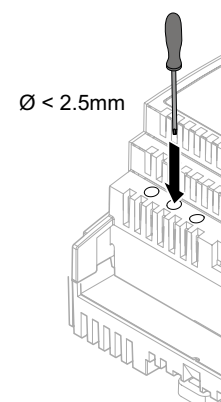









#### NOTICE!

When a reset is carried out by pressing the button, all settings and data in the device are irretrievably deleted.

## LED indicator

The following operating statuses of the IP coupler are displayed:

| Status <sup>4)</sup> | Indicator/display   | Description  |
|----------------------|---|--|
| Continuous green     |  | Normal mode  |
| Flashing green       |  | Identification via CASE Sun                        |
| Continuous orange    |  | Start-up mode <sup>5)</sup>                        |
| Flashing orange      |  | The internal backup battery must be replaced       |
| Continuous red       |  | No CASE Engine plan in the device                  |
| Flashing red         |  | Program download or configuration active           |
| Rapidly flashing red |  | Internal device error                              |
| Green→red→orange     |  | Reset button pressed:<br>> 10 sec. = factory reset |
| Off→Green→Red        |  | LED test sequence                                  |

## Programming and parameterisation

The complete user program (Engine Plan) and the different parameterisations (BACnet objects, images for moduWeb Unity, etc.) are created using CASE Suite. The engine plan is created for the modulo 6 automation station and loaded into it. The necessary configuration data is then transferred from the automation station to the modu612-LC. All devices (automation station and IP coupler) must be connected and functional for a complete transfer to take place.

Every modu612 must be configured for communication in an Ethernet network. All settings, such as the IP address, subnet mask, gateway and the link to the automation station, are parameterised via CASE Sun. Automatic configuration via DHCP servers is also possible.

To be able to visually identify the modu612-LC in a network, the CASE Sun commissioning tool can be used to put the run/fault LED in flashing mode.

The modu612-LC contains a fast operating program. This reads all inputs, transfers them to the automation station, receives new values from the automation station and updates the outputs.

## Initialisation

The modu612-LC can be initialised with CASE Sun before the download.

## Firmware/update

The modu612-LC is delivered with the latest firmware. If a firmware update is available during commissioning, it can be installed directly via the network with CASE Sun. When an update is active, the LED indicator flashes red.

### Note



Only operate the modu612-LC with the latest firmware. Before commissioning, check the firmware version and carry out an update if necessary. Use the same firmware version for the IP coupler and for the automation station.

The version of the installed firmware can be read via CASE Sun.

## moduWeb Unity

The embedded moduWeb Unity web server is available ex works for configuring the modu612-LC ("System" menu item), e.g.

- User administration
- IP settings

<sup>4)</sup> LED flashing: 500 ms on, 500 ms off

LED flashing rapidly: 100 ms on, 100 ms off

LED test sequence: 1 second off > 1 second green > 1 second red

<sup>5)</sup> During the start-up process, it lights up red briefly, then green and then orange again.

- Security settings
- Licensing
- Various system information

### Internal clock

A real-time clock (RTC) is integrated in the modu612-LC. The time is automatically synchronised via the automation station.



#### Note

Correct time and date information is crucial for encrypted communication. Incorrect information leads to the rejection of attempts to establish encrypted communication.

### Battery

A lithium battery (plug-in button cell) ensures that the date and time are retained in the event of a power failure.

The battery should be replaced after five to ten years. During battery replacement, the current time of the internal clock is lost and must be reset. If necessary, contact SAUTER Service to replace the battery.



#### WARNING!

Risk of explosion if the battery is short-circuited during replacement.

- ▶ Only trained specialist personnel may carry out the replacement.
- ▶ Follow the instructions in the fitting instructions for the device.
- ▶ Only replace the battery when the automation station is disconnected from the power supply.
- ▶ Only use insulated tools.

### Technical data for the battery

|                 |                                      |
|-----------------|--------------------------------------|
| Type (standard) | CR2032 lithium button-cell (UN 3091) |
| Nominal voltage | 3 V                                  |
| Capacity        | 210 mAh                              |
| Dimensions      | 20 mm × 3.2 mm                       |

### Behaviour in case of power failure

During power interruptions, the device is switched off in the correct manner. When the power returns, the system is switched back on according to priority. The behaviour for switching off and on is defined autonomously by the device.

If the modulo 6 automation station fails or communication between the automation station and the modu612 LC is interrupted, the outputs connected to the IP coupler are set to the default values defined in the diagram (provided a configuration is loaded). The default values are also set when the modu612-LC is restarted until communication with the automation station is established.



#### Note

Power failures in the EY-PS031 switched-mode power supply on the primary side (230 VAC) that last less than 100 ms are bridged without switching off or other consequences. The system continues to run in normal mode.

If the power supply from a modu601-LC is interrupted, which changes the integrity of the I/O bus, the I/O bus is resynchronised. The modules that can still be reached by the automation station are out of operation for about five seconds, and are then back in operation. This happens in the event of a power failure and when power is restored. After the power returns, all modules should be operational. When an automation station is restarted, it is essential for the modu601-LC power supply to be already present.

### Extension options

To extend the system, additional I/O or communication modules (CM) can be used. The modules are arranged in a row on the right-hand side of the IP coupler and thus connected via the I/O bus spring contacts.

The IP coupler automatically detects the modules connected to the I/O bus. The module attribution and the allocation of inputs and outputs must additionally be carried out by the CASE Engine software in the automation station.

The number of locally pluggable modules is limited to 10. Up to two additional lines can be created using the modu602-LC coupling kit.

### Maximum scaling per automation station

|  | Automation station |            |
|--|--------------------|------------|
|  | modu680-AS         | modu660-AS |
| Number of modu612-LC per automation station              | 4                  | 3          |
| Total number of IO or CM modules in a system environment | 26                 | 26         |

#### Note



The number of IO or CM modules and the number of modu612-LC that can be linked to an automation station depends on the limit of data points or BACnet objects of the automation station and the effective data traffic that is generated.

The bus cover supplied with the IP coupler must be placed on the last module.

A maximum of two COM modules (modu6\*\*CM) can be used on each IP coupler. The COM modules must be used at positions 1 to 2.

#### NOTICE!



Destruction of electronics!

- ▶ Only add or remove I/O modules when the IP coupler is disconnected from the power supply.
- ▶ The current loading of maximum 1300 mA for the station must not be exceeded. This must be ensured in advance during the engineering.

The maximum current loading is the sum of all the connected devices including the I/O modules and operating units.

The information on the current consumption of the individual I/O modules and operating and indicating units can be found on the respective product data sheets.

### Local operation (web server, SAUTER app)

The IP coupler can display its configuration status on a compatible mobile device using the SAUTER modulo 6 app via the Bluetooth interface. In addition, an IP network-capable device can be logged on to moduWeb Unity via a web browser that supports standard HTML5 to visualise and adapt the configuration.

#### Note



The local operating level of the product is not suitable as an emergency operating level according to Machine Directive 2006/42/EU. Standard EN ISO 13849-1 has not been considered. If applicable, a local emergency operating device must be installed on the plant side.

### Access security

#### NOTICE!



Priority operating units can lose their priority function.

- ▶ Limit the access to the local operating level (including via apps) on site.
- ▶ Consider the access security during the planning and risk assessment of the plant.

### Channel and terminal assignment

|              | Description           | Terminal |
|--------------|-----------------------|----------|
| Power supply | PE (functional earth) | 11       |
|              | 24 V-                 | 12       |
|              | 24 V+                 | 13       |

## Protection mechanisms at application level

In combination with the modulo 6 automation station, the IP coupler has the following protection mechanisms:

### Process manager

Productive processes take precedence over other processes such as web server communication and REST API and BT interfaces. The control processes of the building automation are always a priority.

### Access rights

Access to the web server and the API and BT interfaces is protected by user name and password. The first time a user logs in to the web server, the default password must be changed. The user administration and the setting of the access rights are the responsibility of the system operator. An auto-logout or the duration of a login can be set up.

The physical USB, LAN and SD interfaces can be activated or deactivated by authorised users with CASE Sun or via the web server.

### Functional safety

The modulo 6 product series is not suitable for plants or applications that require functional safety (software class A). The modulo 6 products do not have an SIL class and are not fail-safe.

### Data security

Together with a Building Data Integrity Manager (e.g. modu615-BM), the integrity of the project data is periodically checked using patented blockchain technology.

A factory reset is possible via the reset button, which deletes all settings and certificates (for TLS).

### Communication security

Internet communication is encrypted where technically possible. The HTTPS and SMTP protocols, for example, are encrypted.

The system only allows communication via authorised ports. All other ports are blocked by the on-board firewall. In addition, an authorisation list with approved devices can be created.

### Firmware update

Only firmware updates signed by SAUTER can be installed.

## Additional information

|  |            |
|--|------------|
| Fitting instructions                         | P100018129 |
| Declaration on materials and the environment | MD 91.156  |

### Abbreviations used

|           |  |
|-----------|--|
| CE        | Manufacturer's Declaration of Conformity for the European Union (EU)                                       |
| UKCA      | Manufacturer's Declaration of Conformity for the United Kingdom of Great Britain and Northern Ireland (UK) |
| EMC-D     | Electromagnetic Compatibility Directive 2014/30/EU   |
| EMC-2016  | Electromagnetic Compatibility Regulations 2016 (UK)  |
| LVD       | Low Voltage Directive 2014/35/EU   |
| EESR-2016 | Electrical Equipment (Safety) Regulations 2016 (UK)  |
| RED       | Radio Equipment Directive 2014/53/EU   |
| RER-2017  | Radio Equipment Regulations 2017 (UK)  |
| RoHS-D    | RoHS Directives 2011/65/EU and 2015/863/EU   |
| RoHS-2012 | Restriction of Hazardous Substances (RoHS) Regulations 2012 (UK)   |

## Disposal

When disposing of the product, observe the currently applicable local laws.

More information on materials can be found in the Declaration on materials and the environment for this product.



### Connection diagram

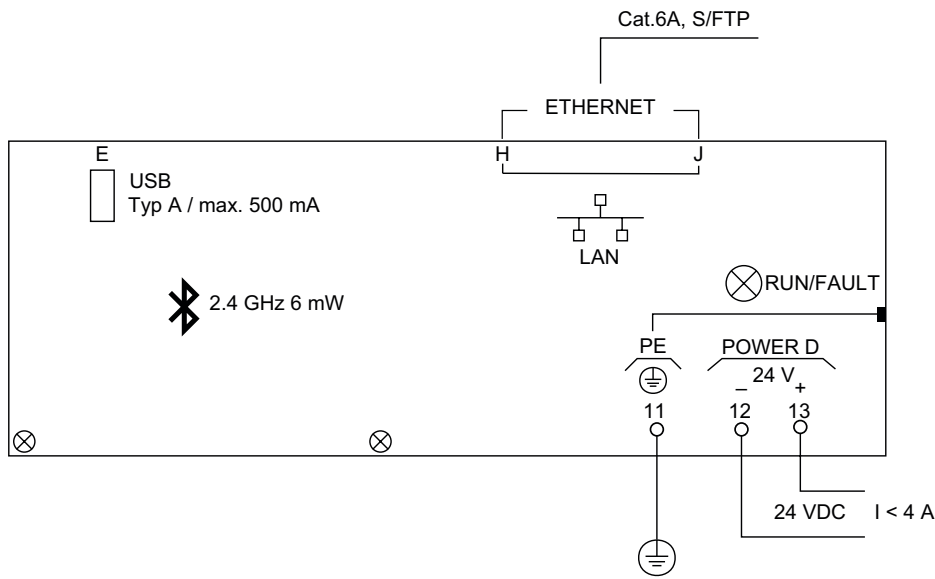

### Dimension drawing

All dimensions in mm.

